

CARATTERISTICHE TECNICHE

TECHNICAL CHARACTERISTICS

Codice Part No.	Pressione Max Max Pressure		Portata Flow rate		Temp. Max Max Temp.	Inlet Port Entrata	Outlet Port Uscita	By-pass
	bar	PSI	l/min	GPM	°C			
1.099-509.0	280	4050	80	21	90	G1/2" F	G1/2" F	G1/2" F

DIMENSIONI D'INGOMBRO

OVERALL DIMENSIONS

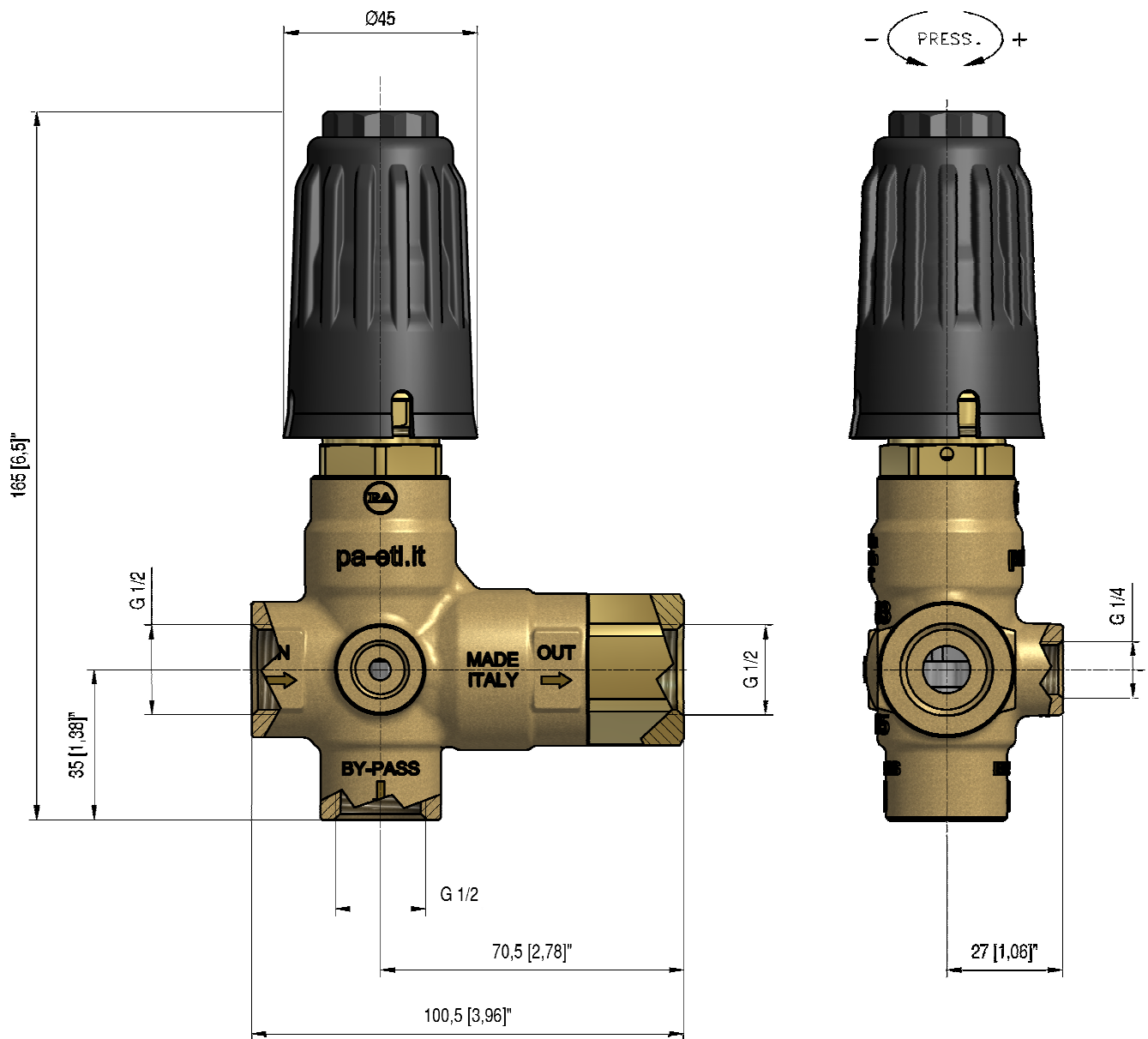

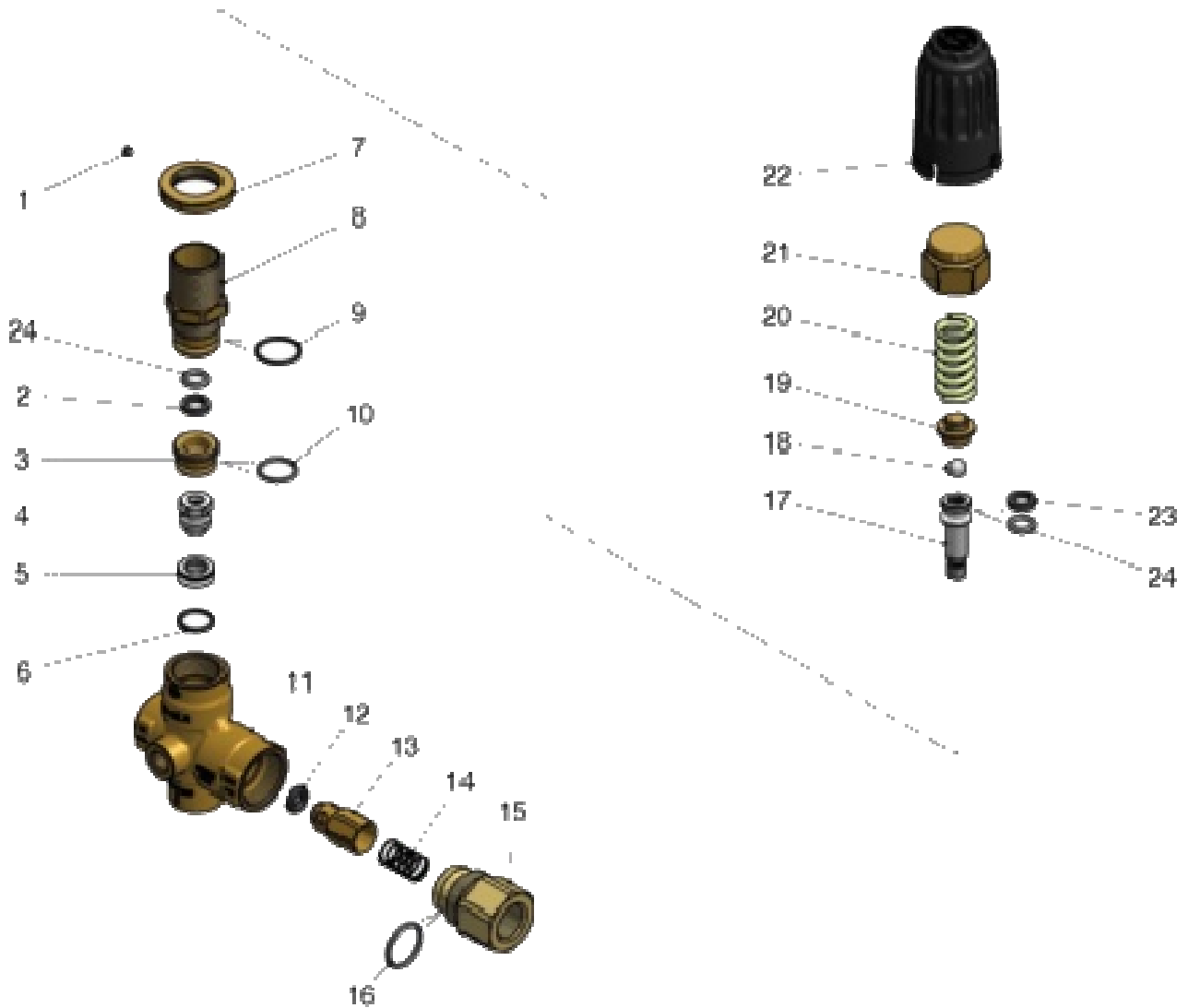

SPARE PARTS KIT

KIT RICAMBIO

CODICE CODE	POS.	Q.TA' Q.TY
1.904-921.0	2	1
	4	1
	5	1
	6	1
	9	1
	10	1
	12	1
	16	1
	23	1
	24	2